

324D L 324D LN

Hydraulic Excavators



Cat® C7 Diesel Engine with ACERT™ Technology

Net Power (ISO 9249) at 1800 rpm

Standard	124 kW/169 hp
----------	---------------

Optional (high power)	140 kW/190 hp
-----------------------	---------------

Operating Weight	25 300 to 27 100 kg
------------------	---------------------

Maximum Travel Speed	5.4 km/h
----------------------	----------

Maximum Reach at Ground Level	10 300 mm
-------------------------------	-----------

Maximum Digging Depth	6740 mm
-----------------------	---------

324D L and 324D LN Hydraulic Excavators

The D Series incorporates innovations for improved performance, controllability and versatility.

Engine

- ✓ The Cat® C7 engine with ACERT™ Technology offers better fuel efficiency and reduced wear. It works at the point of combustion to optimize engine performance and provide low exhaust emissions. By combining ACERT Technology with the new Economy Mode and Power Management, customers can balance the demands of performance and fuel economy to suit their requirements and application. **pg. 4**

Hydraulics

- ✓ The hydraulic system has been designed to provide reliability and outstanding controllability with increased digging forces, lifting capacity and drawbar pull. The Cat Tool Control System provides enhanced flexibility. The Heavy Lift Mode maximizes lifting performance and maintains excellent stability. **pg. 5**

Operator Station

- ✓ Provides maximum space, wider visibility and easy access to switches. The monitor is a full-color graphical display that allows the operator to understand the machine information easily. Overall, the new cab provides a comfortable environment for the operator. **pg. 6**

Environmentally Responsible Design

- ✓ Quieter operation, lower engine emissions, less fluid disposal and cleaner service can help you meet or exceed worldwide regulations and protect the environment. **pg. 4**

SmartBoom™

More productive. Faster cycle times for truck loading and rock scraping. Maintains optimum hammering frequency for effective, steady productivity. **pg. 5**

Excellent controllability and reliability, impressive lift capacity, better fuel efficiency, simplified service and a more comfortable operator station to increase your productivity and lower your operating costs.

✓ *New feature*



Electronic Control System

- ✓ The compact, full-color, graphical display monitor displays machine, maintenance, diagnostic and prognostic information in twenty different languages. The new Economy Mode and Power Management is also selected from the monitor. To minimize sun glare, the monitor angle is adjustable. **pg. 7**

Booms, Sticks and Linkage

- ✓ Caterpillar excavator booms and sticks are built for performance and long service life. Three types of booms and four sticks are available, offering a range of configurations suitable for a wide variety of applications. The bucket linkage pins have been enlarged to improve reliability and durability. All booms and sticks are stress relieved. **pg. 10**

Structures

- ✓ Caterpillar design and manufacturing techniques assure outstanding durability and service life from these important components. The 324D comes standard with grease lubricated tracks. Cat designed excavator undercarriage is stable, durable and low maintenance for good machine stability and transportability. **pg. 8**



Work Tools and GET

A variety of work tools, including buckets, couplers, hammers, crushers, pulverizers, multiprocessors, shears and grapples are available. **pg. 11**

Service and Maintenance

- ✓ Fast, easy service has been designed in with extended service intervals, advanced filtration, convenient filter access and user-friendly electronic diagnostics for increased productivity and reduced maintenance costs. **pg. 9**

Complete Customer Support

Your Cat dealer offers a wide range of services that can be set up under a customer support agreement when you purchase your equipment. The dealer will help you choose a plan that can cover everything from machine and attachment selection to replacement. **pg. 9**

Engine

Built for power, reliability, economy and low emissions.

Meeting regulations... Exceeding expectations.



Performance. The Cat C7 engine with ACERT Technology offers more engine power, and runs at lower speeds for better fuel efficiency and reduced wear. The 324D is available with two engine power versions:

- Standard power (124 kW)
- Optional High power (140 kW)

Power Management. Optimal machine performance for each type of application. The operator can change the engine

power on the monitor from standard to high. The high power mode is recommended for extremely productive areas and for hard digging applications.

Automatic Engine Speed Control.

The two-stage, one-touch control maximizes fuel efficiency and reduces sound levels.

Engine Controller. ADEM™ A4 (Advanced Diesel Engine Management) electronic control module manages fuel delivery to get the best performance per liter of fuel. The controller uses sensors in fuel, air intake, exhaust and cooling systems and provides flexible fuel mapping, allowing the engine to respond quickly to varying application needs. It tracks engine and machine conditions while keeping the engine operating at peak efficiency.

Fuel Delivery. The Cat C7 features electronic controls that govern the mechanically actuated unit fuel injection system. Multiple injection

fuel delivery involves a high degree of precision. Precisely shaping the combustion cycle lowers combustion chamber temperatures, generating fewer emissions and optimizing fuel combustion. This translates into more work output for your fuel cost.

Cooling System. To reduce fan noise, the cooling fan is driven from a viscous clutch which is electrically controlled by the machine ECM. It calculates optimum fan speed based on the target engine speed, coolant temperature, hydraulic oil temperature and actual fan speed. The Cat C7 delivers a completely new layout that separates the cooling system from the engine compartment.

Air Cleaner. The radial seal air filter features a double-layered filter core for more efficient filtration and is located in a compartment behind the cab. A warning is displayed on the monitor when dust accumulates above a preset level.

Environmentally Responsible Design

Caterpillar machines not only help you build a better world, they help maintain and preserve the fragile environment.



Emissions. The Cat C7 with ACERT Technology introduces a series of evolutionary, incremental improvements that provide breakthrough engine technology built on systems and components developed by Caterpillar with proven reliability. The technology capitalizes on Cat expertise in four core engine systems: fuel, air, electronics and after treatment. By combining ACERT Technology with the new Economy Mode, customers can balance the demands of performance and fuel economy to suit their requirements and application. ACERT engines meet EC Stage IIIA emissions regulation.

Fewer Leaks and Spills. Engine oil and encapsulated hydraulic oil filters are positioned vertically and are easy to reach to minimize spillage. Service intervals are extended to reduce the times fluids are changed and handled.

- Hydraulic oil service interval can be extended to 4000 hours with the S•O•S program.
- In addition to the S•O•S program fine filtration system attachment extends the service interval to 5000 hours.
- Cat Extended Life Coolant extends service to 6000 h, less need for fluid disposal.
- The hydraulic system is compatible with Cat HEES hydraulic bio-oil for ecologically sensitive applications.

Hydraulics

Cat hydraulics deliver power and precise control to keep material moving.



Component Layout. The 324D hydraulic system and component locations have been designed to provide a high level of system efficiency. The main pumps, control valves and hydraulic tank are located close together to allow for shorter tubes and lines between components, which reduce friction loss, and pressure drops in the lines. The layout further provides greater operator comfort by placing the radiator on the cab side of the upper structure. This allows incoming air to enter the engine compartment from the operator side and hot air and corresponding engine sound to exit on the opposite side away from the operator. This reduces engine compartment heat and sound being transmitted to the operator.



Heavy Lift Mode. Maximizing lifting performance and boosting the lifting capability. Heavy loads can be easily moved in the full working range of the machine maintaining excellent stability.

Hydraulic Cross Sensing System. The hydraulic cross system utilizes each of two hydraulic pumps to 100%, under all operating conditions. This improves productivity with faster implement speeds and quicker, stronger pivot turns.

Pilot System. The pilot pump is independent from the main pumps and controls the front linkage, swing and travel operations.

Boom and Stick Regeneration Circuit. Boom and stick regeneration circuit saves energy during boom-down and stick-in operation which increases efficiency, reduces cycle times and pressure loss for higher productivity, lower operating costs and increased fuel efficiency.



Electronic Control System.

Ten hydraulic pump flow and pressure settings can be preset, eliminating the need to adjust the hydraulics each time a tool is changed.

Auxiliary Valve. The auxiliary valve is standard. Control circuits are optional, allowing for operation of high and medium pressure tools such as shears, grapples, hammers, pulverizers, etc.

Hydraulic Cylinder Snubbers.

Located at the rod-end of the boom cylinders and both ends of the stick cylinders to cushion shocks while reducing sound levels and extending component life.

SmartBoom. Reduces stress and vibrations transmitted to the machine and provides a more comfortable environment.

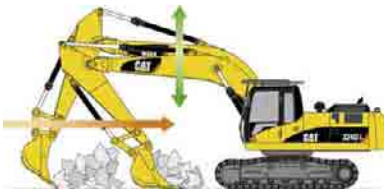

Rock Scraping. Scraping rock and finishing work is easy and fast. SmartBoom simplifies the task and allows the operator to concentrate on stick and bucket, while boom freely goes up and down without using pump flow.



Hammer Work. The front parts automatically follow the hammer while penetrating the rock. Blank shots or excessive force on the hammer are avoided resulting in longer life for the hammer and the machine. Similar advantages with vibratory plates.

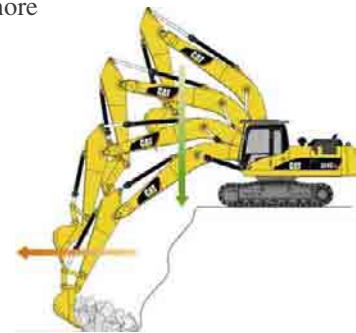

Truck Loading. Loading trucks from a bench is more productive and fuel efficient as the return cycle is reduced while the boom down function does not require pump flow.

Operator Station

Designed for simple, easy operation and comfort, the 324D allows the operator to focus on production.



Operator Station. The workstation is spacious, quiet and comfortable, assuring high productivity during a long workday. The air conditioner and attachment switches are conveniently located on the right-hand wall, and the key switch and throttle dial are on the right-hand console. The monitor is easy to see and maximizes visibility.

Seat. An optional air suspension seat is available in the 324D. The standard and optional seats provide a variety of adjustments to suit the operator's size and weight including fore/aft, height and weight. Wide adjustable armrests and a retractable seat belt are also included.

Climate Control. Positive filtered ventilation with a pressurized cab is standard. Fresh air or re-circulated air can be selected with a switch on the right console.

Hydraulic Activation Control Lever.

For added safety, this lever must be in the operate position to activate the machine control functions.

Controls. The 324D uses pilot operated control levers, positioned so the operator can operate with arms on the armrests. The vertical stroke is longer than the horizontal, reducing operator fatigue. The control lever grips are shaped to fit into the operator's hands. The horn switch and one-touch low idle switch are positioned on the left and right grip.

Implement Controls. Easy to handle joysticks with integrated push buttons and sliding switches control all implement and swing functions. The sliding switches provide modulated control for hydro-mechanical tools and are designed to increase operator comfort and reduce operator fatigue.



Skylight. A unique large polycarbonate skylight provides very good upward visibility, especially useful in above ground applications.

Windows. To maximize visibility, all glass is affixed directly to the cab eliminating the use of window frames. Choice of fixed or easy-to-open split front windshield meet operator preference and application conditions.

- 50/50 split front windshield allows both upper and lower portions to be stored in an overhead position.
- 70/30 split front windshield stores the upper portion above the operator. The lower front windshield features a rounded design to maximize downward visibility and improves wiper coverage.
- Both openable versions feature a one-touch action release system.
- The fixed front windshield is available in standard duty laminated glass or high impact resistant laminated glass.

Wiper. Designed to maximize visibility in poor weather conditions. The parallel wiper system covers almost the complete front window without leaving unwiped areas in the immediate line of sight of the operator.

Cab Exterior. The exterior design uses thick steel tubing along the bottom perimeter of the cab, improving the resistance of fatigue and vibration. This design allows the FOGS to be bolted directly to the cab, at the factory or as an attachment later, enabling the machine to meet specifications and job site requirements.

Electronic Control System

Manages the engine and hydraulics for maximum performance.



Consoles. Redesigned consoles feature a simple, functional design to reduce operator fatigue, ease of switch operation and excellent visibility. Both consoles have attached armrests with height adjustments.

Cab Mounts. The cab shell is attached to the frame with viscous rubber cab mounts, which dampen vibrations and sound levels while enhancing operator comfort.

Standard Cab Equipment. To enhance operator comfort and productivity, the cab includes a lighter, drink holder, coat hook, service meter, literature holder, magazine rack and storage compartment.

Monitor Display Screen. The monitor is a full color 400x234 pixels Liquid Crystal Display (LCD) graphic display. The Master Caution Lamp blinks ON and OFF when one of the critical conditions below occurs:

- Engine oil pressure low
 - Coolant temperature high
 - Hydraulic oil temperature high
- Under normal conditions or the default condition, the monitor display screen is divided into four areas; clock and throttle dial, gauge, event display and multi-information display.

Clock and Throttle Dial Area. The clock and the throttle dial position are in this area and the gas-station icon with green color is also displayed.

Gauge Area. Three analog gauges, fuel level, hydraulic oil temperature and coolant temperature, are displayed in this area.

Event Display Area. Machine information is displayed in this area with the icon and language.

Multi-information Display Area. This area is reserved for displaying information that is convenient for the operator. The "CAT" logo mark is displayed when information to display does not exist.

Keypad. The keypad allows operator to select machine operation conditions and to set view preferences.



Structure

324D structural components and undercarriage are the backbone of the machine's durability.

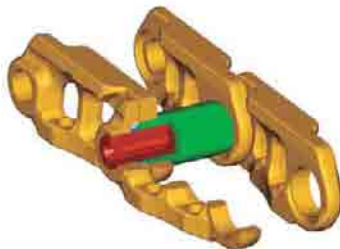

Structures. Proven structural manufacturing techniques, assure outstanding durability and service life from these important components.

Robotic Welding. Up to 95% of the structural welds on a Caterpillar Excavator are completed by robots. Robotic welds achieve over three times the penetration of manual welds.

Carbody Design and Track Roller Frames. X-shaped, box-section carbody provides excellent resistance to torsional bending. Robot-welded track roller frames are press-formed, pentagonal units to deliver exceptional strength and service life.

Undercarriage. Durable Cat undercarriage absorbs stresses and provides excellent stability.

Rollers and Idlers. Sealed and lubricated track rollers, carrier rollers, and idlers provide excellent service life, to keep the machine in the field longer.

Undercarriage Options. Two undercarriage options, long (L) and long narrow (LN) allow you to choose the best machine for your application and business needs.

Long Undercarriage. The long undercarriage (L) maximizes stability and lift capacity. A long, wide and sturdy undercarriage offers a very stable work platform.

Long Narrow Undercarriage. The long and narrow undercarriage (LN) provides the best choice when ease of transport is important while maintaining excellent lift capacity.

Tracks. The 324D comes standard with grease lubricated tracks. The track links are assembled and sealed with grease to decrease internal bushing wear, reduce travel noise and extend service life lowering operating costs.

Service and Maintenance

Simplified service and maintenance save you time and money.



Air Filter Compartment. The air filter features a double-element construction for superior cleaning efficiency.

When the air cleaner plugs, a warning is displayed on the monitor screen inside the cab.

Ground Level Service. The design and layout of the 324D was made with the service technician in mind. Many service locations are easily accessible at ground level allowing critical maintenance to get done quickly and efficiently.

Pump Compartment. A service door on the right side of the upper structure allows ground-level access to the pump and pilot filter.

Capsule Filter. The hydraulic return filter, a capsule filter, is situated outside the hydraulic tank. This filter prevents contaminants from entering the system when hydraulic oil is changed and keeps the operation clean.

Diagnostics and Monitoring. The 324D is equipped with S•O•SSM sampling ports and hydraulic test ports for the hydraulic system, engine oil, and for coolant. A test connection for the Electronic Technician (ET) service tool is located behind the cab.

Anti-Skid Plate. Anti-skid plate covers top of storage box and upper structure to prevent slipping during maintenance.

Fan Guard. Engine radiator fan is completely enclosed by fine wire mesh, reducing the risk of an accident.

Greasing Points. A concentrated remote greasing block on the boom delivers grease to hard-to-reach locations on the front.

Radiator Compartment. The left rear service door allows easy access to the engine radiator, oil cooler and air-to-air aftercooler. Reserve tank and drain cock are attached to the radiator for simplified maintenance.



Extended Service Intervals. 324D service and maintenance intervals have been extended to reduce machine service time and increase machine availability.

Complete Customer Support

Cat dealer services help you operate longer with lower costs.



Machine Selection. Make detailed comparisons of the machines you are considering before you buy. What are the job requirements, machine attachments and operating hours? What production is needed? Your Cat dealer can provide recommendations.

Purchase. Consider the financing options available as well as day-to-day operating costs. This is also the time to look at dealer services that can be included in the cost of the machine to yield lower equipment owning and operating costs over the long run.

Customer Support Agreements.

Cat dealers offer a variety of product support agreements, and work with customers to develop a plan the best meets specific needs. These plans can cover the entire machine, including attachments, to help protect the customer's investment.

Operation. Improving operating techniques can boost your profits. Your cat dealer has videotapes, literature and other ideas to help you increase productivity, and Caterpillar offers certified operator training classes to help maximize the return on your investment.

Product Support. You will find nearly all parts at our dealer parts counter. Cat dealers utilize a worldwide computer network to find in-stock parts to minimize machine downtime. You can save money with Cat remanufactured components.

Maintenance Services. Repair option programs guarantee the cost of repairs up front. Diagnostic programs such as Scheduled Oil Sampling, Coolant Sampling and Technical Analysis help you avoid unscheduled repairs.

Replacement. Repair, rebuild or replace? Your Cat dealer can help you evaluate the cost involved so you can make the right choice.

Booms, Sticks and Linkage

Designed for flexibility, high productivity, and efficiency in a variety of applications.

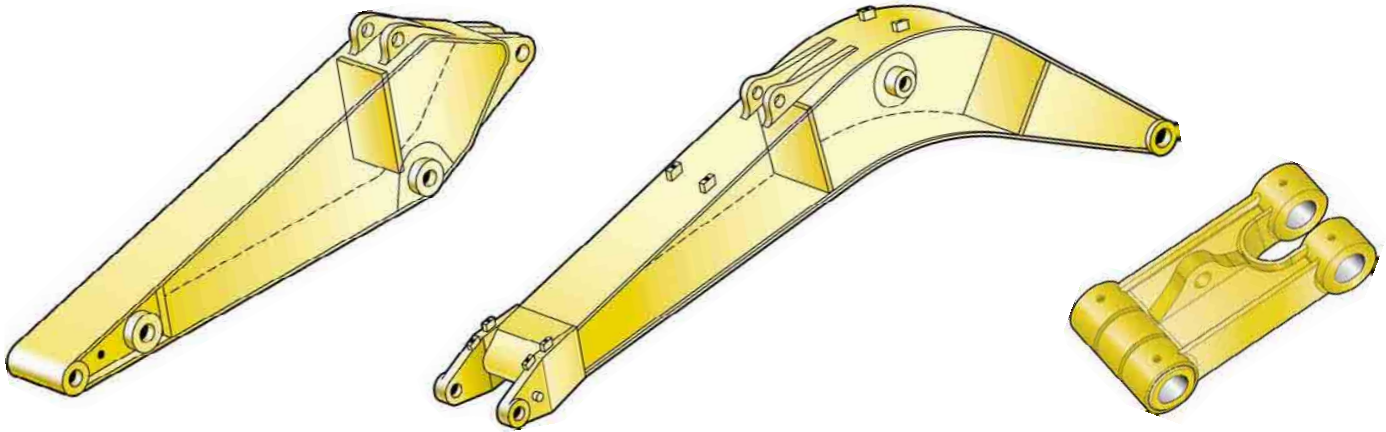

Front Linkage Attachments. Select the right combination of front linkage with your Cat dealer to ensure high productivity from the very start of your job. Three types of booms and four sticks are available, offering a range of configurations suitable for a wide variety of applications and offer a large combination of reach and digging forces for optimum versatility. All booms and sticks undergo a stress relieving process for greater durability.

Boom Construction. The booms have large cross-sections and internal baffle plates to provide long life durability.

Reach Boom. The reach boom (5900 mm) is designed to balance reach, digging force bucket capacity, offering a wide range of applications as digging, loading, trenching and working with hydraulic tools.

Mass Excavation Boom. The mass boom (5300 mm) is designed to provide maximum digging forces, bucket capacity and truck loading productivity.

Variable Adjustable Boom. It offers superb flexibility and versatility in the working envelope. Boom position can be adjusted from 90° when fully retracted to 165° when fully extended. With full extension, the working range gives both maximum dig depth, reach and working height. Equally, when the VA boom is retracted, it can work closer to its tracks, increase lifting capacity and work in confined areas.

Stick Construction. Sticks are made of high-tensile strength steel using a large box section design with interior baffle plates and an additional bottom guard to protect against damage.

Reach Sticks. Two lengths of reach sticks are available to suite a variety of applications. Reach sticks use the CB1 linkage.

- R2.9CB1. The 2950 mm stick gives the largest working envelope with medium-sized buckets.
- R2.5CB1. The 2500 mm stick uses larger capacity CB1 family buckets and is best suited for trenching, excavation and general construction applications.

Mass Sticks. Two mass excavation sticks are available for higher digging forces and increased bucket capacity.

- M2.0DB and M2.5DB. The 2000 mm and 2500 mm sticks provide excellent digging envelope with large bucket capacity and high force levels.

Reach Sticks with VA Boom.

The 2950 mm and 2500 mm sticks provide the necessary strength in digging, lifting and hammering applications with the VA boom.



Bucket Linkage. Two bucket linkages (CB1 and DB) are available, with lifting eye on the power link.

Power Link. The new power link improves durability, increases machine-lifting capability in key lifting positions, and is easier to use compared to the previous lift bar design.

Linkage Pins. All pins used in front linkages have thick chrome plating, giving them high wear and corrosion resistance. The large diameter pins smoothly distribute the shear and bending loads to help ensure long pin, boom and stick life.

Work Tools

A wide variety of Work Tools help optimize machine performance. Purpose designed and built to Caterpillar's high durability standards.

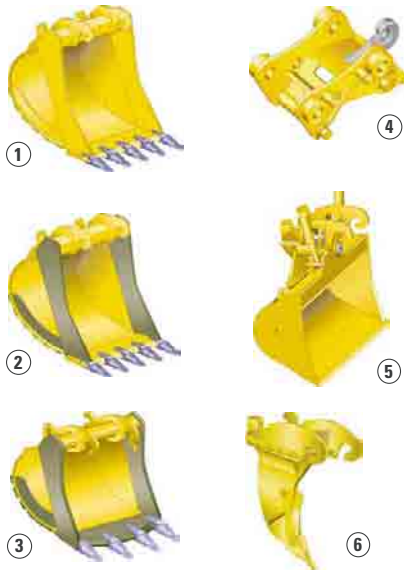

- 1 Excavation (X)
- 2 Extreme Excavation (EX)
- 3 Rock (R)
- 4 Quick Coupler
- 5 Ditch Cleaning
- 6 Ripper



Work Tools. Caterpillar work tools are designed to function as an integral part of your excavator and to provide the best possible performance in your particular application. All work tools are performance-matched to Cat machines.

Quick Couplers. Quick couplers enable the operator to simply release one work tool and connect to another, making your hydraulic excavator highly versatile. Productivity also increases, as a carrier no longer needs to be idle between jobs. Caterpillar offers hydraulic and spindle quick coupler versions.

Buckets. Caterpillar offers a wide range of specialized buckets, each designed and tested to function as an integral part of your excavator. Buckets feature the new Caterpillar K Series™ Ground Engaging Tools.

Ripper. The Caterpillar TR-series ripper provides a powerful single point of penetration force to break out rock and other difficult to excavate material.

Hammers. Cat hammer series deliver very high blow rates, increasing the productivity of your tool carriers in demolition and construction applications. Wide oil flow acceptance ranges make the Caterpillar hammers suitable for a wide range of carriers and provide a system solution from one safe source.

Orange Peel Grapples. The orange peel grapple is constructed of high-strength, wear-resistant steel, with a low and compact design that makes it ideal for dump clearance. There are several choices of tine and shell versions.

Multi-Grapples. The multi-grapple with unlimited left and right rotation is the ideal tool for stripping, sorting, handling and loading. The powerful closing force of the grab shells combined with fast opening/closing time ensures rapid cycle time which translates to more tons per hour.

Multi-Processors. Thanks to its single basic housing design, the multi-processor series of hydraulic demolition equipment makes it possible to use a range of jaw sets that can handle any demolition job. The multi-processor is the most versatile demolition tool on the market.

Vibratory Plate Compactors. Cat compactors are performance-matched to Cat machines, and integrate perfectly with the Cat hammer line – brackets and hydraulic kits are fully interchangeable between hammers and compactors.

Shears. Cat shears provide superior and effective scrap processing, and are highly productive in demolition environments. Shears are compatible with a matching Cat excavator, and bolt-on brackets are available for either stick or boom-mounted options.

Bucket Specifications

Without Quick Coupler						Reach boom 5900 mm				ME boom 5300 mm								
						Linkage	Width mm	Weight* kg	Capacity (ISO) m ³	Fill Factor %	324D L		324D LN		324D L		324D LN	
											2500 mm	2950 mm	2500 mm	2950 mm	2000 mm	2500 mm	2000 mm	2500 mm
Excavation	CB1	600	646	0.49	100					×	×	×	×					
	CB1	750	688	0.67	100					×	×	×	×					
	CB1	1250	919	1.29	100					×	×	×	×					
	CB1	1300	958	1.35	100					×	×	×	×					
	CB1	1350	979	1.42	100					×	×	×	×					
	CB1	1400	1000	1.48	100					×	×	×	×					
	CB1	1500	1043	1.61	100					×	×	×	×					
	CB1	1600	1084	1.74	100					×	×	×	×					
	DB	1000	1124	1.11	100	×	×	×	×									
	DB	1350	1333	1.62	100	×	×	×	×									
	DB	1500	1443	1.84	100	×	×	×	×									
	DB	1600	1501	1.99	100	×	×	×	×									
	DB	1650	1530	2.07	100	×	×	×	×									
	DB	1700	1558	2.14	100	×	×	×	×				N					
DB	1800	1616	2.29	100	×	×	×	×				N						
Extreme Excavation	CB1	750	724	0.67	100					×	×	×	×					
	CB1	1150	926	1.16	100					×	×	×	×					
	CB1	1350	1014	1.42	100					×	×	×	×					
	CB1	1450	1083	1.55	100					×	×	×	×					
	CB1	1500	1104	1.61	100					×	×	×	×					
	CB1	1600	1148	1.74	100					×	×	×	×					
	DB	1350	1454	1.62	100	×	×	×	×									
	DB	1500	1549	1.84	100	×	×	×	×									
	DB	1600	1647	1.99	100	×	×	×	×									
	DB	1650	1678	2.07	100	×	×	×	×				N					
	DB	1700	1710	2.14	100	×	×	×	×				N					
Rock	CB1	1350	1096	1.45	90					×	×	×	×					
	DB	1000	1257	1.11	90	×	×	×	×									
	DB	1650	1820	2.07	90	×	×	×	×									
Maximum load in kg (payload plus bucket)						4293	3935	3792	3469	5145	4598	4530	4041					
With Quick Coupler																		
Excavation	CB1	600	615	0.49	100					×	×	×	×					
	CB1	750	611	0.67	100					×	×	×	×					
	CB1	1250	845	1.29	100					×	×	×	×					
	CB1	1300	884	1.35	100					×	×	×	×					
	CB1	1350	904	1.42	100					×	×	×	×					
	CB1	1400	925	1.48	100					×	×	×	×					
	CB1	1500	966	1.61	100					×	×	×	×					
	CB1	1600	985	1.74	100					×	×	×	×					
	DB	1000	1044	1.11	100	×	×	×	×									
	DB	1350	1250	1.62	100	×	×	×	×									
Extreme Excavation	CB1	750	675	0.67	100					×	×	×	×					
	CB1	1150	878	1.16	100					×	×	×	×					
	CB1	1350	966	1.42	100					×	×	×	×					
	CB1	1450	1034	1.55	100					×	×	×	×					
	CB1	1500	1056	1.61	100					×	×	×	×					
	CB1	1600	1100	1.74	100					×	×	×	×					
	DB	1350	1372	1.62	100	×	×	×	×									
	DB	1500	1466	1.84	100	×	×	×	×									
Rock	CB1	1350	1048	1.45	90					×	×	×	×					
	DB	1000	1213	1.11	90	×	×	×	×									
Maximum load in kg (payload plus bucket)						4043	3685	3542	3219	4795	4248	4180	3691					

* Bucket weight including penetration plus tips



Max. Material Density
1200 kg/m³



Max. Material Density
1500 kg/m³



Max. Material Density
1800 kg/m³



Not recommended



Not compatible

Work Tools Matching Guide

		Reach boom 5900 mm				ME boom 5300 mm			
		324D L		324D LN		324D L		324D LN	
		2500	2950	2500	2950	2000	2500	2000	2500
Without quick coupler		mm							
Hammers	H120C s, H130 s, H140D s								
Multiprocessors	MP15 CC, CR, PP, PS, S					N	N	N	N
	MP20 CC, CR, PS, S, MP20 PP, TS								
Crushers and Pulverizers	VHC-30					N	N	N	N
	VHC-40								
	VHP-30					N	N	N	N
	VHP-40								
Hydraulic Shears	S320					N	N	N	N
	S325		N	N	N				
	S340*								
Mechanical Grapples	G115								
	G125	N	N	N	N				N
Multi Grapples	G315					N	N	N	N
	G320								
	G320B-D, -R								
Vibratory Plate Compactor	CVP110								
Clamshell Buckets (rehandling)	GOS-35 620, 700, 780								
	GOS-35 1050, 1260								
	GOS-35 1460, 1670								
	GOS-45 970								
	GOS-45 1120								
	GOS-45 1270								
	GOS-45 1580				N				
	GOS-45 1710				N				
	GOS-45 2020		N	N	N				N
GOS-45 2340	N	N	N	N		N	N	N	
Orange Peel Grapples	5 tines	GSH20B 600, 800							
		GSH20B 1000							
		GSH22B 600							
		GSH22B 800				N			
		GSH22B 1000		N	N	N			
	GSH22B 1250	N	N	N	N			N	
	4 tines	GSH20B 600, 800, 1000							
		GSH22B 600							
		GSH22B 800							
		GSH22B 1000				N			
GSH22B 1250				N	N				

* Boom mounted

With quick coupler

Quick Couplers	CW-40, CW-40S CW-45, CW-45S								
Hammers	H120C s, H130 s, H140D s								
Multiprocessors	MP15 CC, CR, PP, PS, S					N	N	N	N
	MP20 CC, PS								
	MP20 CR, S MP20 PP, TS				N				
Crushers and Pulverizers	VHC-30, VHP-30					N	N	N	N
	VHC-40, VHP-40								
Hydraulic Shears	S320					N	N	N	N
	S325	N	N	N	N				N
Mechanical Grapples	G115								
	G125	N	N	N	N		N	N	N
Multi Grapples	G315					N	N	N	N
	G320								
	G320B-D G320B-R								
Vibratory Plate Compactor	CVP110								

360° Working range

Best choice

Max. Material Density 1200 kg/m³

Over the front only

Quick coupler match

Max. Material Density 1800 kg/m³

N Not recommended

Max. Material Density 3000 kg/m³

Engine

Cat C7 with ACERT Technology

Standard Net Power at 1800 rpm

ISO 9249	124 kW/169 hp
----------	---------------

80/1269/EEC	124 kW/169 hp
-------------	---------------

Optional Net Power at 1800 rpm

ISO 9249	140 kW/190 hp
----------	---------------

80/1269/EEC	140 kW/190 hp
-------------	---------------

Bore	110 mm
------	--------

Stroke	127 mm
--------	--------

Displacement	7.2 liters
--------------	------------

- All engine horsepower (hp) are metric including front page.
- The C7 engine meets Stage IIIA emission requirements.
- Net power advertised is the power available at the flywheel when the engine is equipped with fan, air cleaner, muffler, and alternator.
- Full engine net power up to 2300 m altitude (engine derating required above 2300 m).

Sound

Operator Sound

- The operator sound level measured according to the procedures specified in ISO 6394:1998 is 75 dB(A), for cab offered by Caterpillar, when properly installed and maintained and tested with the doors and windows closed.
- Hearing protection may be needed when operating with an open operator station and cab (when not properly maintained or doors/windows open) for extended periods or in noisy environment.

Exterior Sound

- The labeled spectator sound power level measured according to the test procedures and conditions specified in 2005/88/EC is 104 dB(A).

Cab/FOGS

Cab/FOGS meets ISO 10262.

Hydraulic System

Main System

Maximum flow	2 x 220 l/min
--------------	---------------

Maximum pressure

Normal	350 bar
--------	---------

Heavy lift	360 bar
------------	---------

Travel	350 bar
--------	---------

Swing	245 bar
-------	---------

Pilot System

Maximum flow	32.4 l/min
--------------	------------

Maximum pressure	39 bar
------------------	--------

Boom Cylinder

Bore	135 mm
------	--------

Stroke	1305 mm
--------	---------

Stick Cylinder

Bore	140 mm
------	--------

Stroke	1660 mm
--------	---------

CB1 Family Bucket Cylinder

Bore	130 mm
------	--------

Stroke	1156 mm
--------	---------

DB Family Bucket Cylinder

Bore	150 mm
------	--------

Stroke	1151 mm
--------	---------

Machine and Major Component Weights

Actual weights and ground pressures will depend on final machine configuration.

		Reach boom 5900 mm		ME boom 5300 mm		VA boom 5660 mm	
		R2.5CB1	R2.9CB1	M2.0DB	M2.5DB	R2.5CB1	R2.9CB1
Stick type							
Stick length	mm	2500	2950	2000	2500	2500	2950
Bucket weight	kg	925	904	1466	1372	925	904
Bucket capacity	m ³	1.5	1.4	1.8	1.6	1.5	1.4
Bucket width/type	mm	1400/X	1350/X	1500/EX	1350/EX	1400/X	1350/X
Operating weight*							
324D L (800 mm shoes)	kg	26 030	26 060	27 040	27 120	26 920	26 960
324D LN (600 mm shoes)	kg	25 330	25 370	26 350	26 430	26 230	26 270
Ground pressure							
324D L (800 mm shoes)	bar	0.40	0.40	0.41	0.41	0.41	0.41
324D LN (600 mm shoes)	bar	0.51	0.51	0.53	0.53	0.53	0.53
Stick weight (without bucket cylinder)	kg	725	785	825	905	725	785
Boom weight (without stick cylinder)	kg	1570		1675		2180	
Upperstructure (without counterweight)	kg	6980		6980		6980	
Undercarriage							
324D L (800 mm shoes)	kg	9240		9240		9240	
324D LN (600 mm shoes)	kg	8545		8545		8545	
Counterweight	kg	4770		4770		4770	

* With counterweight, quick coupler, bucket, operator and full fuel.

Dimensions

All dimensions are approximate.

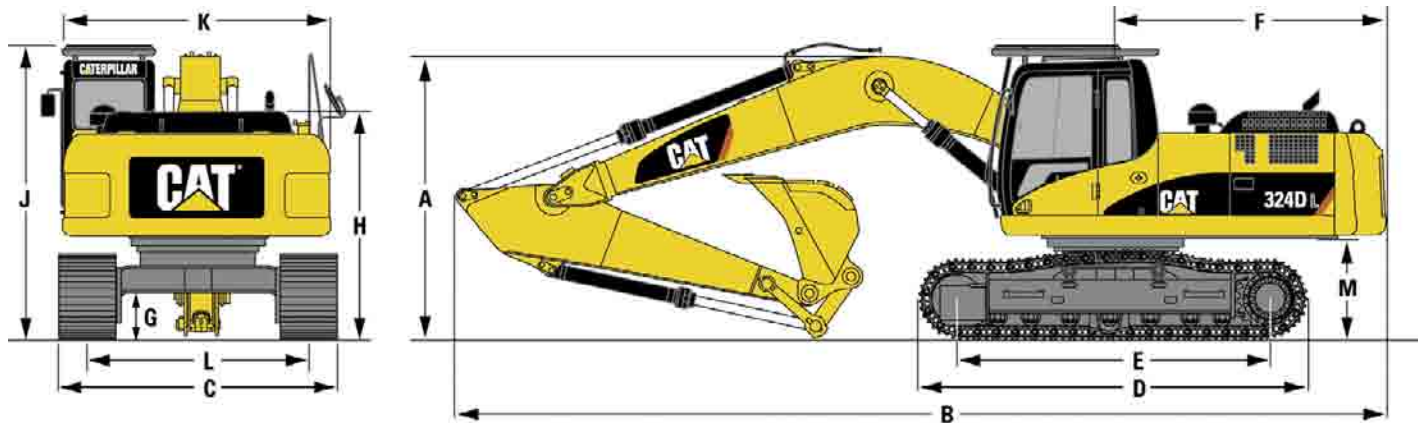

	mm		mm		mm
A Shipping height (with bucket)		B Shipping length		C Track width	
Reach boom		Reach boom		324D L (800 mm shoes)	3390
2500 mm stick	3300	2500 mm stick	10 100	324D LN (600 mm shoes)	2990
2950 mm stick	3170	2950 mm stick	10 060	D Track length	4630
Mass Excavation boom		Mass Excavation boom		E Length to centers of rollers	3830
2000 mm stick	3320	2000 mm stick	9610	F Tail swing radius	3000
2500 mm stick	3450	2500 mm stick	9480	G Ground clearance	440
VA boom		VA boom		H Body height	2480
2500 mm stick	3270	2500 mm stick	10 210	J Cab height	3110
2950 mm stick	3220	2950 mm stick	10 190	K Body width	2900
				L Track gauge	
				324D L	2590
				324D LN	2390
				M Counterweight clearance	1060

Track Width

Standard Undercarriage with triple grouser shoes	
Long (L)	800 mm
Long Narrow (LN)	600 mm
Optional Undercarriage with triple grouser shoes	
Long (L)	600, 700, 900 mm
	600 mm HD, 700 mm HD
Long Narrow (LN)	700, 800 mm
	600 mm HD, 700 mm HD

Drive

Maximum Travel Speed	5.4 km/h
Maximum Drawbar Pull	227 kN

Swing Mechanism

Swing Speed	9.6 rpm
Swing Torque	73.4 kNm

Service Refill Capacities

	Liters
Fuel Tank	520
Cooling System	30
Engine Oil	30
Swing Drive (each)	10
Final Drive (each)	6
Hydraulic system (including tank)	300
Hydraulic tank	257

Working Ranges – Reach Boom (5900 mm)

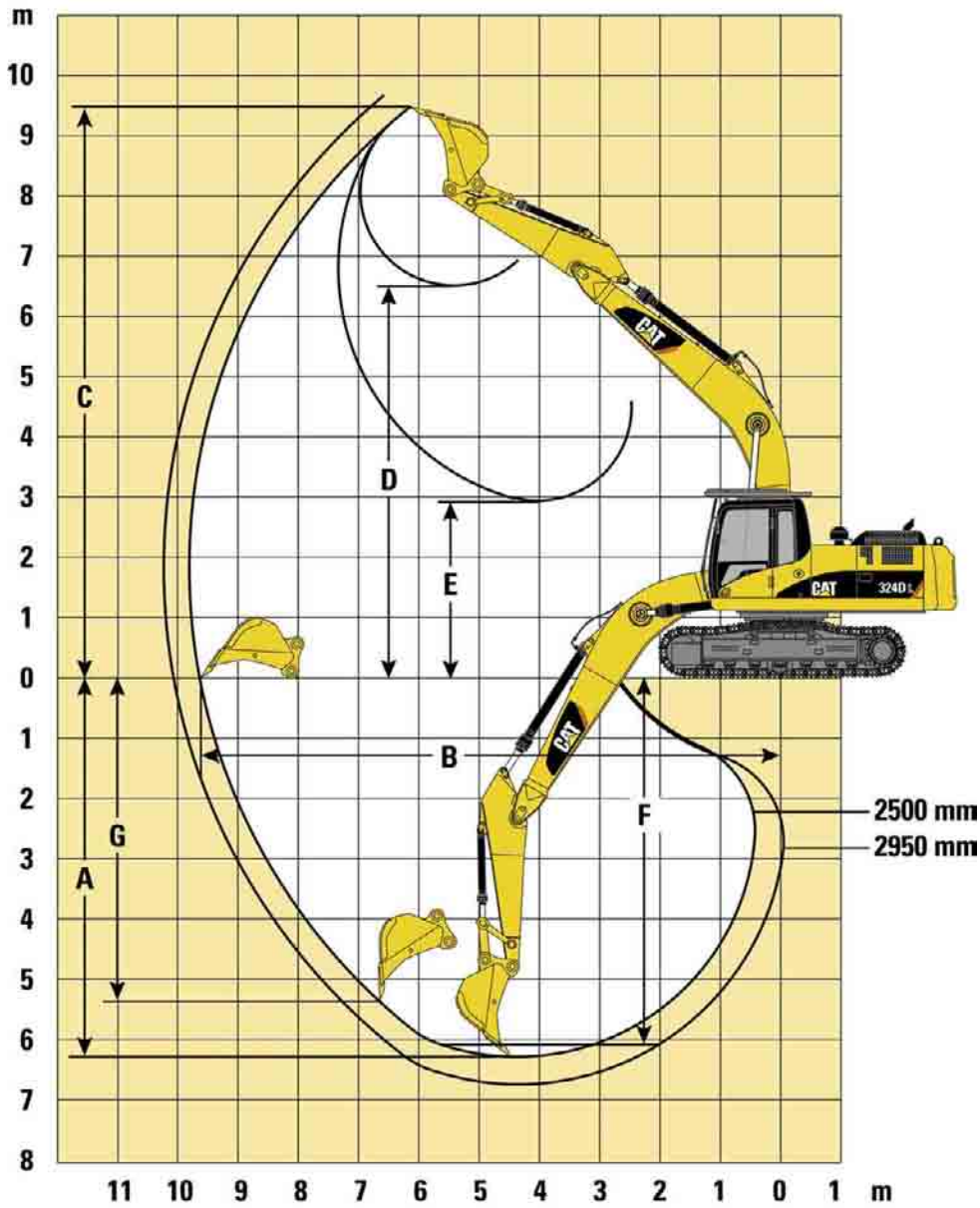

















		R2.5CB1	R2.9CB1
Stick Length	mm	2500	2950
A Maximum Digging Depth	mm	-6290	-6740
B Maximum Reach at Ground Level	mm	9620	10 050
C Maximum Cutting Height	mm	9460	9660
D Maximum Loading Height	mm	6500	6700
E Minimum Loading Height	mm	2930	2470
F Maximum Digging Depth 2500 mm Level Bottom	mm	-6080	-6560
G Maximum Vertical Wall Digging Depth	mm	-5390	-5830
Bucket Tip Radius	mm	1610	1610
Bucket Forces (ISO 6015)	kN	160	149
Stick Forces (ISO 6015)	kN	149	132

















Lift Capacities – Reach Boom (5900 mm)

All weights are in kg, without bucket, with quick coupler, heavy lift on.

















324D L
Medium Stick
 2500 mm
Shoes
 800 mm

	1.5 m		3.0 m		4.5 m		6.0 m		7.5 m		9.0 m				m
															
7.5 m							*6550	*6550					*6250	*6250	6.29
6.0 m							*6610	*6610					*5930	4760	7.41
4.5 m					*8680	*8680	*7370	6600	*6730	4600			*5930	4030	8.09
3.0 m					*11 120	9700	*8480	6280	6810	4450			5620	3670	8.45
1.5 m					*13 240	9040	9380	5960	6640	4300			5440	3530	8.53
0 m					*14 210	8710	9130	5740	6510	4180			5560	3590	8.35
-1.5 m			*10 560	*10 560	*14 100	8630	9030	5650	6470	4140			6040	3880	7.87
-3.0 m			*13 700	*13 700	*13 030	8720	9080	5690					7170	4580	7.03
-4.5 m			*14 350	*14 350	*10 540	8990							*7960	6370	5.7

















324D L
Long Stick
 2950 mm
Shoes
 800 mm

	1.5 m		3.0 m		4.5 m		6.0 m		7.5 m		9.0 m				m
															
7.5 m													*4580	*4580	6.85
6.0 m									*5470	4720			*4360	4310	7.88
4.5 m							*6840	6680	*6310	4630			*4360	3700	8.52
3.0 m					*10 290	9890	*8010	6340	6840	4470			*4520	3390	8.87
1.5 m					*12 640	9170	*9210	6000	6650	4300			*4860	3260	8.95
0 m			*6100	*6100	*13 970	8750	9150	5750	6490	4160			5140	3300	8.77
-1.5 m	*6190	*6190	*10 130	*10 130	*14 200	8600	9000	5620	6420	4090			5530	3540	8.31
-3.0 m	*10 650	*10 650	*14 020	*14 020	*13 450	8640	9000	5620	6450	4120			6410	4100	7.53
-4.5 m			*16 010	*16 010	*11 480	8840	*8320	5780					*7700	5400	6.3

324D LN
Medium Stick
 2500 mm
Shoes
 600 mm

	1.5 m		3.0 m		4.5 m		6.0 m		7.5 m		9.0 m				m
															
7.5 m							*6550	6190					*6250	5680	6.29
6.0 m							*6610	6150					*5930	4270	7.41
4.5 m					*8680	*8680	*7370	5920	*6730	4110			*5930	3600	8.09
3.0 m					*11 120	8610	*8480	5600	6630	3970			5460	3260	8.45
1.5 m					*13 240	7970	9140	5290	6460	3820			5290	3130	8.53
0 m					*14 210	7650	8890	5080	6330	3700			5410	3170	8.35
-1.5 m			*10 560	*10 560	*14 100	7570	8790	4990	6290	3660			5870	3440	7.87
-3.0 m			*13 700	*13 700	*13 030	7660	8840	5030					6980	4060	7.03
-4.5 m			*14 350	*14 350	*10 540	7920							*7960	5650	5.7

324D LN
Long Stick
 2950 mm
Shoes
 600 mm

	1.5 m		3.0 m		4.5 m		6.0 m		7.5 m		9.0 m				m
															
7.5 m													*4580	*4580	6.85
6.0 m									*5470	4240			*4360	3860	7.88
4.5 m							*6840	6000	*6310	4150			*4360	3300	8.52
3.0 m					*10 290	8790	*8010	5670	6660	3990			*4520	3010	8.87
1.5 m					*12 640	8090	9190	5330	6470	3820			*4860	2890	8.95
0 m			*6100	*6100	*13 970	7690	8900	5090	6320	3680			4990	2920	8.77
-1.5 m	*6190	*6190	*10 130	*10 130	*14 180	7540	8760	4960	6240	3610			5370	3130	8.31
-3.0 m	*10 650	*10 650	*14 020	*14 020	*13 450	7580	8760	4960	6270	3650			6240	3630	7.53
-4.5 m			*16 010	15 330	*11 480	7770	*8320	5110					*7700	4790	6.3



Load Point Height



Load Radius Over Front



Load Radius Over Side



Load at Maximum Reach

* Limited by hydraulic rather than tipping load.

The above loads are in compliance with hydraulic excavator lift capacity ratings standard ISO 10567, they do not exceed 87% of hydraulic lifting capacity or 75% of tipping capacity. Weight of all lifting accessories must be deducted from the above lifting capacities.

Working Range – Mass Excavation Boom (5300 mm)

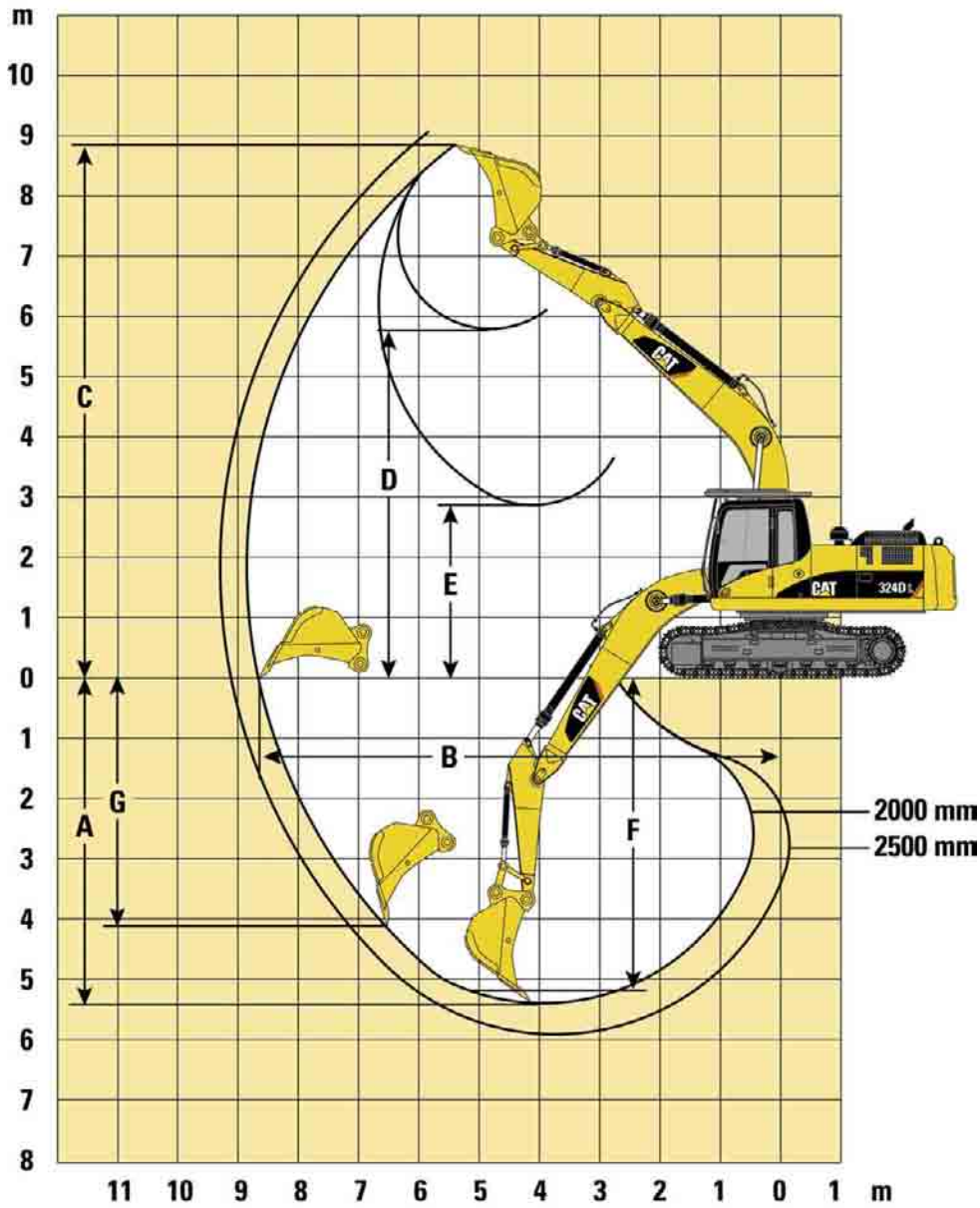

		M2.0DB	M2.5DB
Stick Length	mm	2000	2500
A Maximum Digging Depth	mm	-5410	-5910
B Maximum Reach at Ground Level	mm	8650	9110
C Maximum Cutting Height	mm	8830	9050
D Maximum Loading Height	mm	5750	5970
E Minimum Loading Height	mm	2860	2360
F Maximum Digging Depth 2500 mm Level Bottom	mm	-5190	-5720
G Maximum Vertical Wall Digging Depth	mm	-4120	-4590
Bucket Tip Radius	mm	1764	1764
Bucket Forces (ISO 6015)	kN	186	177
Stick Forces (ISO 6015)	kN	171	154

Lift Capacities – Mass Excavation Boom (5300 mm)

All weights are in kg, without bucket, with quick coupler, heavy lift on.

















324D L

Short Stick

2000 mm

Shoes

800 mm

	1.5 m		3.0 m		4.5 m		6.0 m		7.5 m		9.0 m				m	
																
7.5 m														*7680	*7860	4.81
6.0 m							*7650	6600						*6940	6210	6.2
4.5 m					*9180	*9180	*7980	6460						*6830	4950	7.01
3.0 m					*11350	9650	*8870	6170						6790	4380	7.42
1.5 m					*13310	8990	9320	5880	6560	4200				6530	4180	7.52
0 m					*14150	8660	9100	5680						6750	4290	7.3
-1.5 m			*16790	*16790	*13760	8610	9050	5630						7590	4800	6.75
-3.0 m			*16610	*16610	*11950	8790								*8840	6150	5.75

















324D L

Medium Stick

2500 mm

Shoes

800 mm

	1.5 m		3.0 m		4.5 m		6.0 m		7.5 m		9.0 m				m	
																
7.5 m														*6000	*6000	5.5
6.0 m							*6850	6710						*5510	5420	6.75
4.5 m							*7340	6530						*5420	4440	7.49
3.0 m					*10450	9830	*8330	6220	6700	4320				*5600	3960	7.88
1.5 m					*12670	9110	9360	5900	6540	4180				5930	3790	7.97
0 m			*9490	*9490	*13930	8680	9080	5660	6420	4070				6090	3860	7.77
-1.5 m	*8720	*8720	*15330	*15330	*13970	8540	8970	5560						6730	4250	7.25
-3.0 m	*15280	*15280	*18210	17480	*12700	8640	9060	5630						8340	5230	6.34
-4.5 m					*9100	9020								*8250	8180	4.8

















324D LN

Short Stick

2000 mm

Shoes

600 mm

	1.5 m		3.0 m		4.5 m		6.0 m		7.5 m		9.0 m				m	
																
7.5 m														*7680	*7680	4.81
6.0 m							*7650	5910						*6940	5560	6.2
4.5 m					*9180	*9180	*7980	5780						*6830	4420	7.01
3.0 m					*11350	8550	*8870	5490						6610	3890	7.42
1.5 m					*13310	7920	9080	5210	6380	3720				6360	3700	7.52
0 m					*14150	7600	8860	5010						6560	3790	7.3
-1.5 m			*16790	14860	*13760	7550	8810	4970						7390	4240	6.75
-3.0 m			*16610	15220	*11950	7720								*8840	5440	5.75

















324D LN

Medium Stick

2500 mm

Shoes

600 mm

	1.5 m		3.0 m		4.5 m		6.0 m		7.5 m		9.0 m				m	
																
7.5 m														*6000	*6000	5.5
6.0 m							*6850	6020						*5510	4850	6.75
4.5 m							*7340	5850						*5420	3950	7.49
3.0 m					*10450	8730	*8330	5550	6520	3840				*5600	3510	7.88
1.5 m					*12670	8030	9110	5230	6360	3700				5770	3350	7.97
0 m			*9490	*9490	*13930	7610	8840	4990	6250	3590				5920	3410	7.77
-1.5 m	*8720	*8720	*15330	14680	*13970	7480	8730	4890						6540	3750	7.25
-3.0 m	*15280	*15280	*18210	14960	*12700	7570	8810	4970						8120	4610	6.34
-4.5 m					*9100	7940								*8250	7220	4.8



Load Point Height



Load Radius Over Front



Load Radius Over Side



Load at Maximum Reach

* Limited by hydraulic rather than tipping load.

The above loads are in compliance with hydraulic excavator lift capacity ratings standard ISO 10567, they do not exceed 87% of hydraulic lifting capacity or 75% of tipping capacity. Weight of all lifting accessories must be deducted from the above lifting capacities.

Working Ranges – Variable Adjustable Boom (5660 mm)

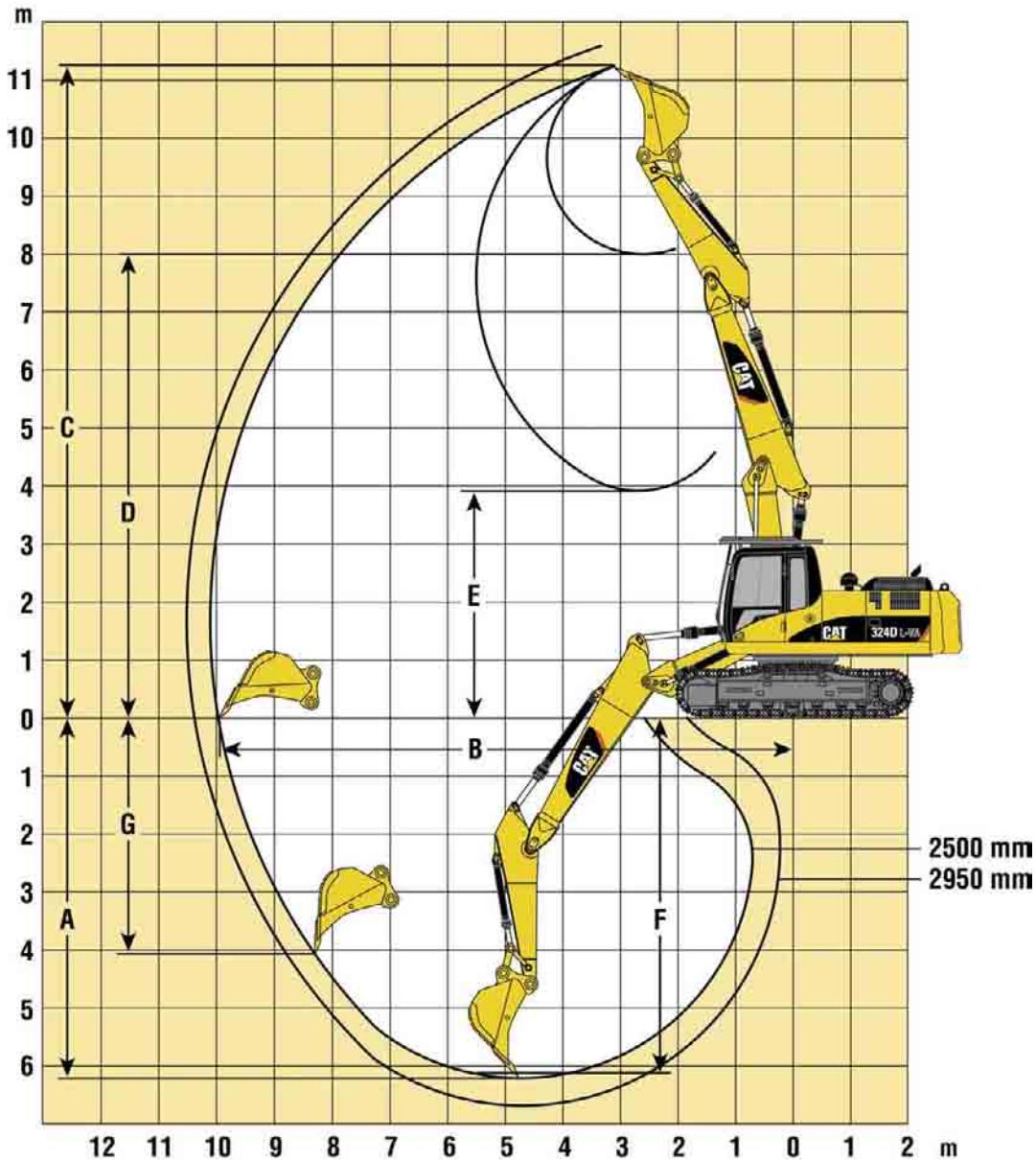

















		R2.5CB1	R2.9CB1
Stick Length	mm	2500	2950
A Maximum Digging Depth	mm	-6217	-6655
B Maximum Reach at Ground Level	mm	9881	10 304
C Maximum Cutting Height	mm	11 237	11 575
D Maximum Loading Height	mm	8007	8346
E Minimum Loading Height	mm	3917	3344
F Maximum Digging Depth 2500 mm Level Bottom	mm	-6112	-6555
G Maximum Vertical Wall Digging Depth	mm	-4066	-4498
Bucket Tip Radius	mm	1610	1610
Bucket Forces (ISO 6015)	kN	160	149
Stick Forces (ISO 6015)	kN	149	132

Lift Capacities – Variable Adjustable Boom (5660 mm)

All weights are in kg, without bucket, with quick coupler, heavy lift on.

















324D L

Medium Stick
2500 mm
Shoes
800 mm

	1.5 m		3.0 m		4.5 m		6.0 m		7.5 m		9.0 m				m
															
9.0 m					*6750	*6750							*6780	*6780	4.86
7.5 m					*7040	*7040	*6610	*6610					*6310	5850	6.6
6.0 m					*8310	*8310	*8320	7100	*6680	4700			*5960	4490	7.67
4.5 m			*16310	*16310	*11630	10700	*9370	7010	7150	4730			5880	3820	8.33
3.0 m			*17770	*17770	*13510	*10390	9820	6810	7080	4650			5410	3480	8.68
1.5 m			*17630	*17630	*14240	10050	9690	6590	6910	4480			5250	3360	8.76
0 m			*15540	*15540	*14190	9620	9660	6270	6720	4310			5360	3410	8.58
-1.5 m			*15900	*15900	*14310	9250	9480	5970	6550	4150			*5780	3690	8.11
-3.0 m			*18720	18160	*14340	9150	9280	5800					*4830	4320	7.31
-4.5 m			*17090	*17090	*9860	9060									

















324D L

Long Stick
2950 mm
Shoes
800 mm

	1.5 m		3.0 m		4.5 m		6.0 m		7.5 m		9.0 m				m
															
9.0 m					*6540	*6540							*5270	*5270	5.59
7.5 m					*6230	*6230	*6280	*6280					*4620	*4620	7.15
6.0 m					*6390	*6390	*6720	*6720	*6000	4820			*4380	4070	8.14
4.5 m			*8720	*8720	*8650	*8650	*8120	7010	7100	4840			*4350	3510	8.77
3.0 m			*18210	*18210	*13010	10390	*9760	6860	*7090	4750	*5040	3290	*4470	3220	9.1
1.5 m			*18140	*18140	*14120	10130	*9680	6620	6940	4580	5040	3220	*4750	3100	9.18
0 m			*17330	*17330	*14140	9740	*9640	6310	6770	4350	4960	3140	4950	3140	9.01
-1.5 m			*16760	*16760	*14210	9290	9530	6050	6580	4180			5310	3360	8.56
-3.0 m			*18690	18100	*14420	9110	9270	5780	*6080	4090			*4850	3870	7.81
-4.5 m			*19650	18280	*11940	9000	*6480	5770							

















324D LN

Medium Stick
2500 mm
Shoes
600 mm

	1.5 m		3.0 m		4.5 m		6.0 m		7.5 m		9.0 m				m
															
9.0 m					*6750	*6750							*6780	*6780	4.86
7.5 m					*7040	*7040	*6610	6330					*6310	5250	6.6
6.0 m					*8310	*8310	*8320	6480	*6680	4200			*5960	4010	7.67
4.5 m			*16310	*16310	*11630	9720	*9370	*6400	6970	4230			5720	3400	8.33
3.0 m			*17770	17300	*13510	9440	9640	6200	6900	4160			5260	3080	8.68
1.5 m			*17630	17080	*14240	*9060	*9520	5900	6730	3990			5100	2960	8.76
0 m			*15540	*15540	*14190	8510	9410	5580	6540	3820			5210	3010	8.58
-1.5 m			*15900	15620	*14310	8150	9240	5290	6370	3670			5640	3250	8.11
-3.0 m			*18720	15590	*14340	8060	9040	5120					*4830	3820	7.31
-4.5 m			*17090	15780	*9860	7970									

324D LN

Long Stick
2950 mm
Shoes
600 mm

	1.5 m		3.0 m		4.5 m		6.0 m		7.5 m		9.0 m				m
															
9.0 m					*6540	*6540							*5270	*5270	5.59
7.5 m					*6230	*6230	*6280	*6280					*4620	4610	7.15
6.0 m					*6390	*6390	*6720	6480	*6000	4340			*4380	3630	8.14
4.5 m			*8720	*8720	*8650	*8650	*8120	6410	6960	4340			*4350	3110	8.77
3.0 m			*18210	17570	*13010	9480	9640	6250	6930	4250	4970	2910	*4470	2840	9.1
1.5 m			*18140	17130	*14120	9110	9480	5980	6790	4080	4900	2840	4730	2730	9.18
0 m			*17330	16400	*14140	8630	9410	5620	6590	3860	4820	2760	4810	2760	9.01
-1.5 m			*16760	15710	*14210	8190	9290	5370	6400	3690			5160	2960	8.56
-3.0 m			*18690	15530	*14420	8010	9030	5100	*6080	3610			*4850	3410	7.81
-4.5 m			*19650	15700	*11940	7900	*6480	5090							



Load Point Height



Load Radius Over Front



Load Radius Over Side



Load at Maximum Reach

* Limited by hydraulic rather than tipping load.

The above loads are in compliance with hydraulic excavator lift capacity ratings standard ISO 10567, they do not exceed 87% of hydraulic lifting capacity or 75% of tipping capacity. Weight of all lifting accessories must be deducted from the above lifting capacities.

Standard Equipment

Standard equipment may vary. Consult your Caterpillar dealer for specifics.

Electrical

- Alternator – 65 amp
- Heavy duty maintenance free batteries (2)
- Lights working
 - Boom, both side
 - Cab interior
 - Cab mounted, two
 - Frame mounted
- Signal/warning horn

Engine

- Automatic engine speed control
- Caterpillar C7 engine (124 kW)
 - Altitude capability to 2300 m
- Fine swing control
- Fuel filter
- High ambient cooling
- Secondary engine shut-off switch
- Side-by-side cooling system with separately mounted AC condenser
- Water separator, with level indicator, for fuel line

Guards

- 6 mm swivel guard on undercarriage
- Heavy duty bottom guards on upper frame
- Heavy duty travel motor guards on undercarriage

Operator Station

- Adjustable armrest
- Air conditioner, heater and defroster with automatic climate control
- Ashtray and 24 volt lighter
- Beverage/cup holder
- Bolt-on FOGS capability
- Capability to install 2 additional pedals
- Coat hook
- Electrical provision for seat heater
- EU sound criteria package
- Floor mat, washable
- Instrument panel and gauges with full color graphical display, start-up level checks
- Laminated front windshield
- Literature compartment
- Mirrors – left and right
- Neutral lever (lock out) for all controls
- Positive filtered ventilation, pressurized cab
- Rear window, emergency exit
- Retractable seat belt
- Sliding upper door window
- Stationary skylight (polycarbonate)
- Storage compartment suitable for a lunch box
- Sunshade for windshield and skylight
- Travel control pedals with removable hand levers
- Windshield wiper and washer (upper and lower)

Undercarriage

- Automatic swing parking brake
- Automatic travel parking brakes
- Grease lubricated track
- Hydraulic track adjusters
- Idler and center section track guards
- Long (L)
- Long Narrow (LN)
- Steps – four
- Triple grouser shoes
 - 324D L – 800 mm
 - 324D LN – 600 mm
- Two speed travel

Other Standard Equipment

- Auxiliary hydraulic valve for hydro-mechanical tools
- Cat branded XT hoses and reusable couplings
- Cat Datalink and capability to use ET
- Caterpillar one key security system with locks for doors, cab and fuel cap
- Cross-roller type swing bearing
- Counterweight with lifting eyes
- Drive for auxiliary pump
- Heavy lift mode
- Regeneration circuit for boom and stick
- S•O•SSM quick sampling valves for engine oil, hydraulic oil and coolant
- Steel firewall between engine and hydraulic pump compartment
- Wiring provisions for Product Link

Optional Equipment

Optional equipment may vary. Consult your Caterpillar dealer for specifics.

Engine

Caterpillar C7 High power engine
(140 kW)

Front Linkage

Bucket linkages

CB1-family for CB1 sticks
with lifting eye)

DB-family for DB sticks
with lifting eye)

Buckets and quick coupler
(see pg. 11-12)

Booms (with two working lights)

Reach

– 5900 mm

Mass excavation

– 5300 mm

VA

– 5660 mm

Sticks

For reach boom

– R2.5CB1

– R2.9CB1

For mass boom

– M2.0DB

– M2.5DB

For VA boom

– R2.5CB1

– R2.9CB1

Tips

Shoes

Triple grouser

324D L – 600 mm, 700 mm, 900 mm

Heavy duty – 600 mm, 700 mm

324D LN – 700 mm, 800 mm

Heavy duty – 600 mm, 700 mm

Guards

FOGS, bolt-on

Full length for L and LN undercarriage
(two piece)

Track end guide for L and LN
undercarriage

Heavy-duty swivel protection (16 mm)

Operator Compartment

Joysticks

Four button joystick or single action
auxiliary control

Thumb wheel modulation joystick

Lunch box storage with lid

Machine security system with
programmable keys

Radio

AM/FM radio mounted in right hand
console with antenna and speakers

Radio ready mounting at rear location
including 24V to 12V converter

Seat

Adjustable high-back seat with
mechanical suspension

Adjustable high-back seat with
air suspension

Adjustable high-back heated seat with
air suspension

Straight travel pedal

Visor rain protection

Windshield

1-piece standard duty

1-piece high impact resistant

50-50 split, sliding

70-30 split, sliding

Auxiliary Controls and Lines

Auxiliary boom lines (high pressure
for reach and mass booms

Auxiliary stick lines (high pressure
for reach and mass booms

Basic control arrangements:

– Single action
(single action tool such as hammer,
with direct return to tank)

– System, combined
(single and double action tools,
direct return to tank)

– System, Medium Pressure AHC
(two directional flow attachment)

– System, Double Medium
Pressure (two function medium
pressure, two directional flow
attachment)

– Circuit, Cooling (circulating
circuit for cooling hydraulic oil)

Universal control group for
quick coupler

Miscellaneous Options

Bio hydraulic oil package

Boom lowering control device with
SmartBoom

Cab front rain protector

Converters, 7 amp-12V

– One

– Two

Electric refueling pump with auto
shut-off

Fine filtration filter

Jump start terminals

Starting aid for cold weather with ether

Stick lowering control device

Travel alarm with cut off switch

324D L and 324D LN Hydraulic Excavators

For more complete information on Cat products, dealer services, and industry solutions, visit us on the web at www.cat.com

Materials and specifications are subject to change without notice. Featured machines in photos may include additional equipment. See your Caterpillar dealer for available options.

© 2007 Caterpillar -- All rights reserved

CAT, CATERPILLAR, their respective logos, "Caterpillar Yellow" and the POWER EDGE trade dress as well as corporate and product identity used herein, are trademarks of Caterpillar and may not be used without permission.

HEHH3328-1 (07/2007) hr

CATERPILLAR[®]